

ASSEMBLY INSTRUCTIONS
for Full Bed Conversion Kit
MAYFIELD 4 IN 1 CONVERTIBLE CRIB
Model #45088

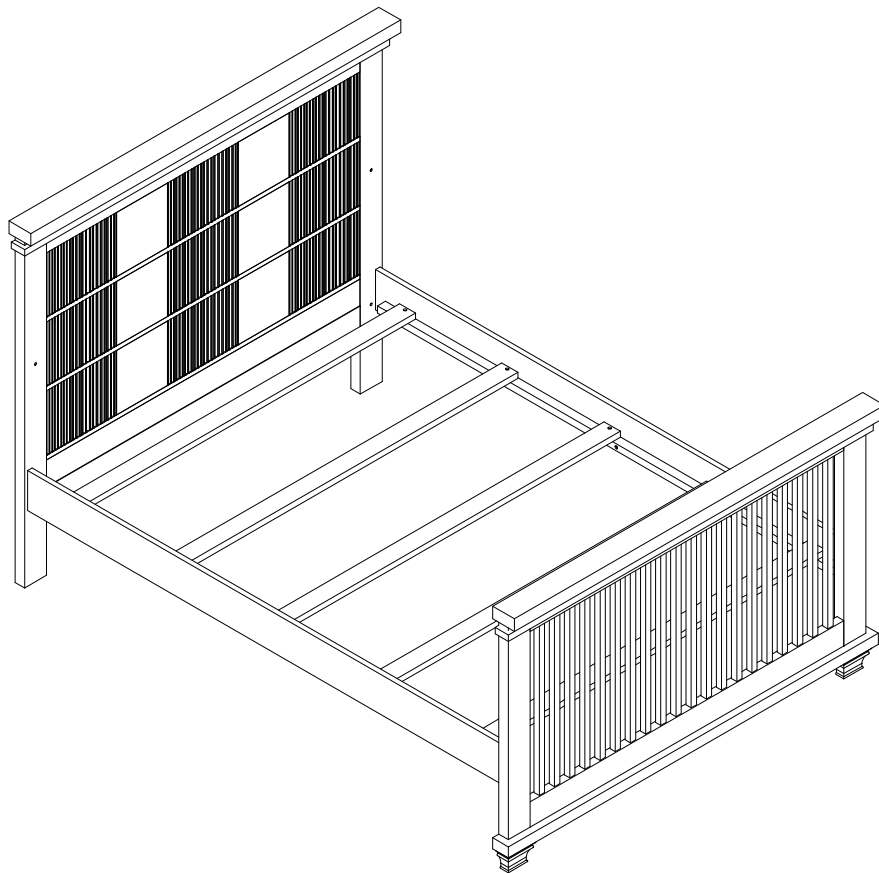

"RECOMMENDATION: We recommend the use of a Bunkie Board or box spring under the mattress for this full bed.

Thank you for your purchase!

Remove all parts and hardware from the box and lay on a carpeted or scratch-free work surface.

Do not dispose of any contents until assembly is completed.

Familiarize yourself with all exhibits and diagrams to facilitate the assembly of your crib.

TOOLS REQUIRED:

ALLEN KEY (Included)



SCREW DRIVER (Not Included)

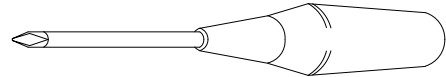

PARTS ENCLOSED IN CARTON

A. Rail (2 pcs)

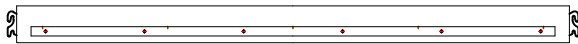

B. Slat (5 pcs)

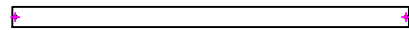

HARDWARE

(C) Allen Bolt 1"(25 mm) (2 pcs)

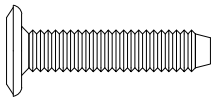

(D) Screw 1 1/4"(30 mm) (10 pcs)

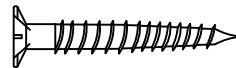

(E) Nut 3/4" (20mm) (2 pcs)

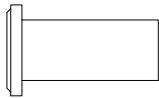

(F) Allen key (2 pcs) (length may vary)



Do not fully tighten all bolts until all parts are in place.

(please add an extra 1/2 revolution to the bolts when using spring washer after tightening)

STEP 1 " ASSEMBLY OF HEADBOARD AND FOOTBOARD"

THIS STEP REQUIRES :

- Head Board (1 pc)
- Foot Board (1 pc)
- A. Rail (2 pcs)

STEP 1.1

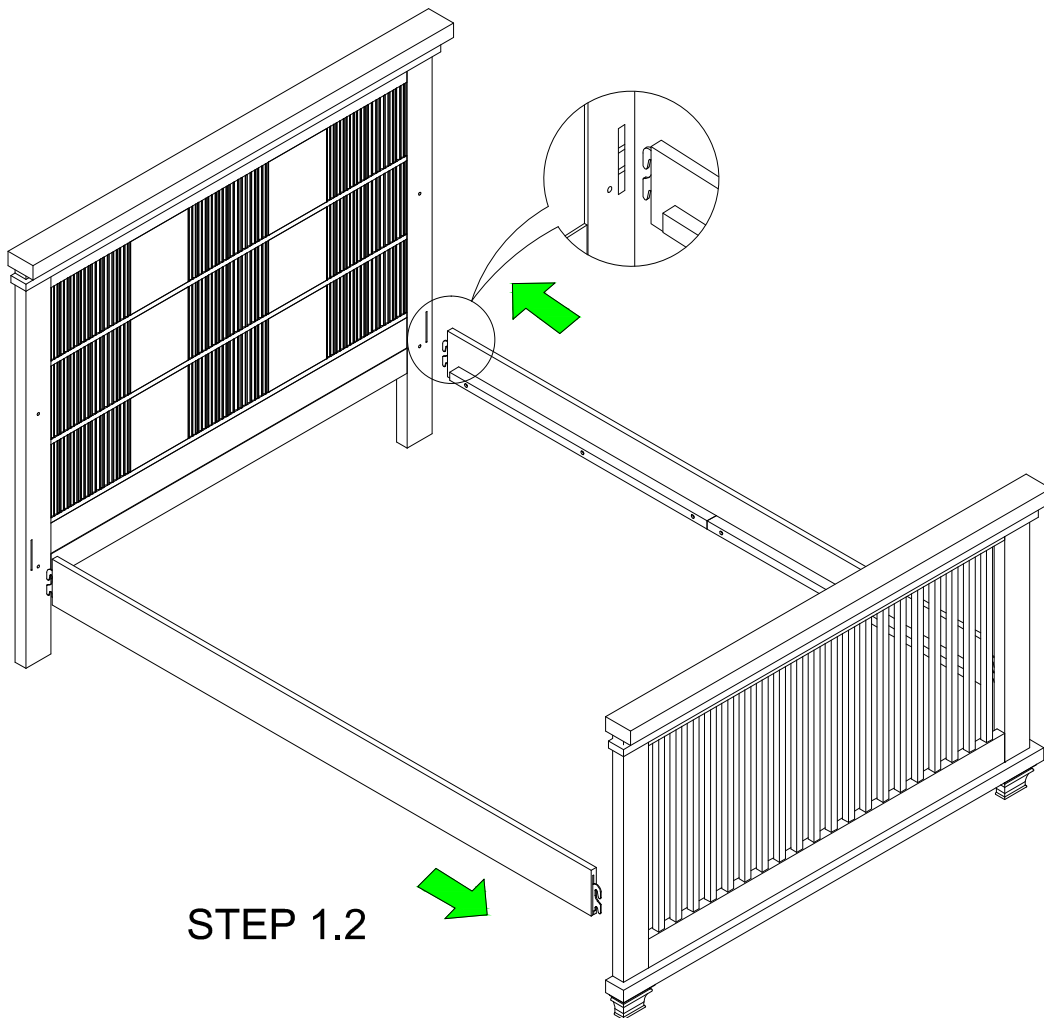

STEP 1.2

STEP 1.1

Place Headboard in vertical position and then hook rails (A) to Headboard.

STEP 1.2

Place Footboard in vertical position and then hook rails (A) to Footboard

STEP 2 " ASSEMBLY OF SLATS"

THIS STEP REQUIRES :

B. Slat (5 pcs)

(F) Allen key (2 pcs)

SCREW DRIVER (Not Included)

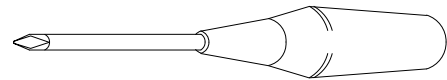

(C) AllenBolt 1"(25 mm) (2 pcs)

(D) Screw 1 1/4"(30 mm) (10 pcs)

(E) Nut 3/4" (20mm) (2 pcs)

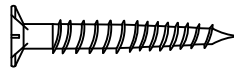
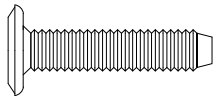

STEP 3

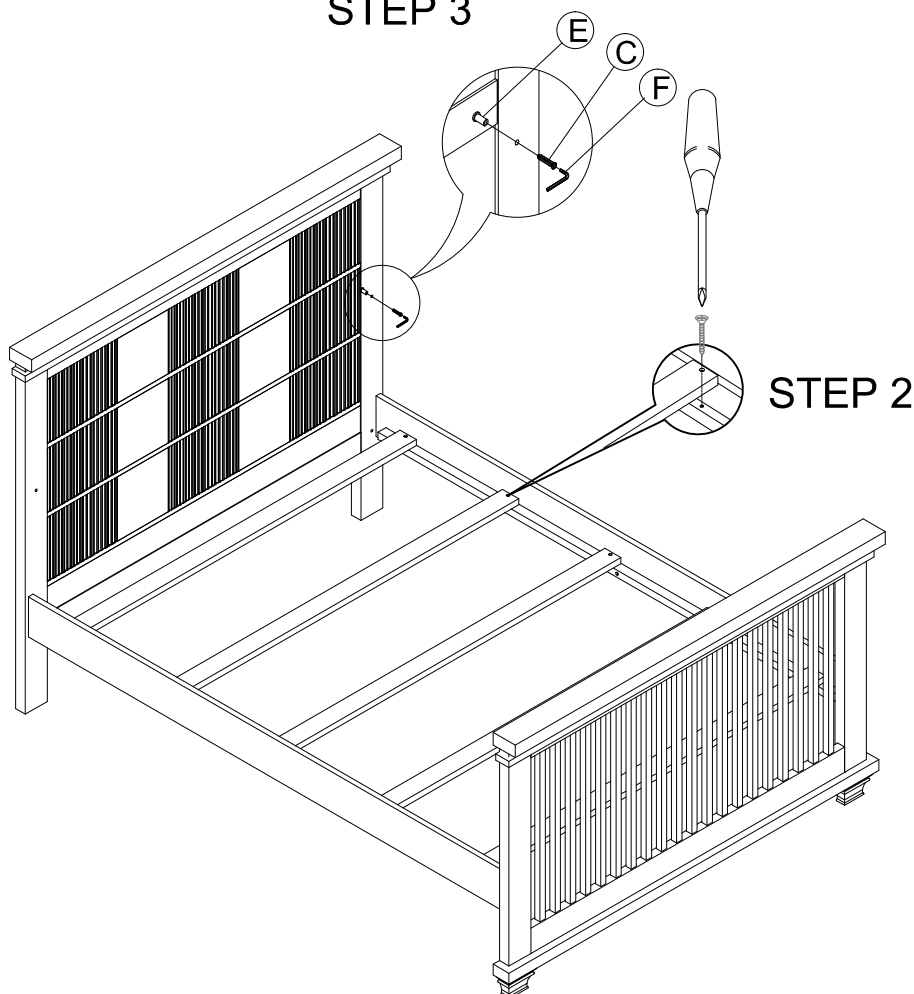

STEP 2

- After attaching Rails (A) to headboard and footboard, place Slat (B) on the support strip of Rail (A), fasten both ends of Slat (B) with screw (D).
Tighten all screws by Screw Driver (not included).

STEP 3

- Insert Allenbolt 1" (25 mm) (C), through the top hole in the headboard from the inside and connect with nut 3/4" (20 mm) (E).
Tighten all bolts and nuts with allen key (F). Assembly complete. Thank you!